



# Source Four Mini LED

## User Manual

Part Number: 7063M1220 Rev K

Released: 2024-09

To view a list of ETC trademarks and patents, go to [etconnect.com/ip](https://etconnect.com/ip). All other trademarks, both marked and not marked, are the property of their respective owners.

For a complete list of all third-party licenses that are fully incorporated herein to the extent required by each third-party license terms and conditions, please visit [etconnect.com/licenses](https://etconnect.com/licenses).

ETC intends this document, whether printed or electronic, to be provided in its entirety.

# Table of Contents

Introduction .....	1
Safety .....	2
Installation .....	5
Install a Lens Tube .....	5
Install OneTrack Luminaire .....	6
Install DataTrack Luminaire .....	7
Use with HALO Miniature Trac or GLOBAL Trac Pro .....	8
Install Canopy Luminaire .....	9
Focus and Setup .....	11
Adjust the Tilt .....	11
Focus the Beam .....	11
Shape the Beam .....	11
Use the Color Frame Holder .....	12
Cleaning .....	13
Specifications and Reference .....	14
FCC Compliance .....	14



# Introduction

The Source Four Mini LED has three available mounting options:

- **Portable:** Includes a yoke-mounted driver, and has a permanently installed power cord with 3-prong Edison connector. Region-specific connectors are available. Contact ETC for available options. Use L5-15 plugs on branch circuits with L5-15 receptacles only. Use an M10 bolt to secure a clamp (provided separately) to the luminaire.
- **Track-mount** and **Canopy:** Both the track-mount luminaires and the canopy luminaire include an integral driver.

You must install a lens tube before you use the Source Four Mini LED. There are four lens tube sizes available: 19°, 26°, 36°, and 50°. See [Install a Lens Tube on page 5](#).

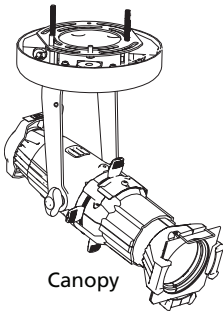

Canopy

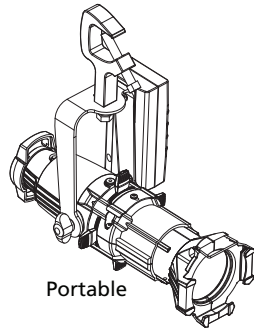

Portable

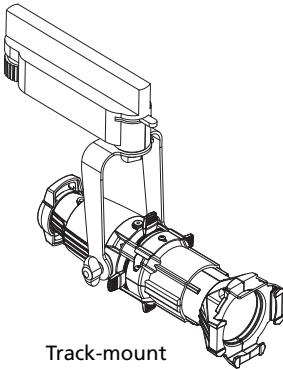

Track-mount  
(DataTrack)

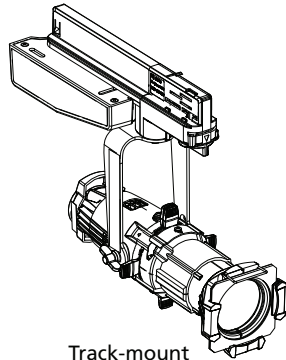

Track-mount  
(OneTrack)

There are also canopy and portable versions of the luminaire that are compatible with the F-drive family of drivers and accessories. See the luminaire datasheets at [etconnect.com](http://etconnect.com) for more information on Source Four Mini LED product options.

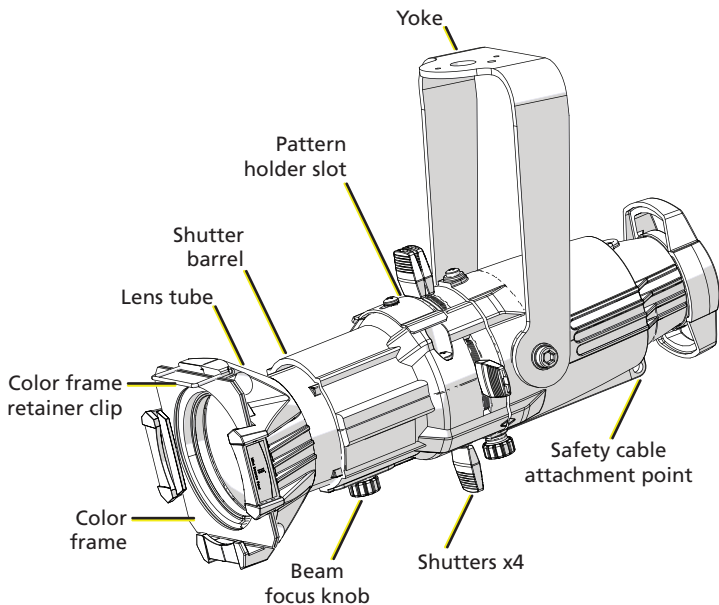

## Safety



**WARNING:** Note the following safety warnings before use:

- Use the luminaire in dry locations only, where humidity does not exceed 90 percent (non-condensing).
- Do not mount the luminaire on or near a flammable surface.
- Check that the accessory holder is locked before mounting the luminaire.
- Do not operate the luminaire without a lens installed.
- Do not use this luminaire if a lens is deeply scratched or cracked. You must replace a lens when it is damaged.



**AVERTISSEMENT :** Prendre connaissance des avertissements de sécurité suivants avant toute utilisation :

- Ne pas installer le projecteur sur ou à côté d'une surface inflammable.
- Vérifiez que le porte-accessoires est verrouillé avant de monter le projecteur.
- N'utilisez pas le projecteur sans que la lentille soit installée.

# IMPORTANT SAFEGUARDS

INSTRUCTIONS PERTAINING TO A RISK OF FIRE, ELECTRIC SHOCK, OR INJURY TO PERSONS

- Keep lamp away from materials that may burn.
- Do not touch hot lens, guard, or enclosure.
- Do not remain in light if skin feels warm.
- Do not look directly at lighted lamp.
- External temperature after 5 minutes of full-brightness operation: 50°C (122°F).
- External temperature when steady state is achieved: 67°C (152.6°F).

## SAVE THESE INSTRUCTIONS

### Canopy Luminaire



**WARNING: RISK OF ELECTRIC SHOCK! Power must be off when you perform this procedure.**

The luminaire must be installed by a qualified electrician in accordance with all national and local electrical and construction codes and regulations.

**AVERTISSEMENT : RISQUE DE DÉCHARGE ÉLECTRIQUE!**  
L'alimentation doit être éteinte avant d'exécuter cette procédure.

### Track-Mount Luminaire







**WARNING: To reduce the risk of fire and electric shock, use the track-mount luminaire only with its designated track system (for example, One Track or DataTrack).**

**AVERTISSEMENT : Pour éviter le risque d'incendie ou de choc électrique, utiliser le luminaire à adaptateur pour rail uniquement avec son système de rail désigné (OneTrack ou DataTrack par exemple).**

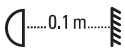

**WARNING: Use the DataTrack track-mount luminaire with ceiling-mounted track only.**

The following symbols may appear on product labeling.

	<p>The luminaire must be installed at least 0.1 m (4.0 in) away from all lighted objects.</p>	<p>Le luminaire doit être installé à au moins 0,1 m (4,0 po) de tout objet éclairé.</p>
	<p>This product should not be discarded as unsorted waste but must be sent to separate collection facilities for recovery and recycling.</p>	<p>Ce produit ne doit pas être jeté avec les déchets ménagers mais doit être déposé dans une collecte de déchets électroniques ou dans un point de collecte.</p>
	<p>This product meets the safety requirements specified for Class II equipment according to IEC 61140 or IEC 60536.</p>	<p>Ce produit à Protection Classe II Double isolation est conforme aux normes IEC 61140 ou IEC 60536.</p>
	<p>This product meets the safety requirements specified for Class III according to IEC 60536.</p>	<p>Produit à Protection Classe III Très basse tension conforme à la norme IEC 60536.</p>



# Installation

## Install a Lens Tube

You must install a lens tube before you use the Source Four Mini LED. There are four lens tube sizes available: 19°, 26°, 36°, and 50°.

Lens Tube	Description
4M19LT (-1, -5)	19° Source Four Mini Lens Tube Only Black (White, Silver)
4M26LT (-1, -5)	26° Source Four Mini Lens Tube Only Black (White, Silver)
4M36LT (-1, -5)	36° Source Four Mini Lens Tube Only Black (White, Silver)
4M50LT (-1, -5)	50° Source Four Mini Lens Tube Only Black (White, Silver)

1. Unscrew the beam focus knob from the loose lens tube.
2. Slide the lens tube into the shutter barrel.
3. Install the beam focus knob.

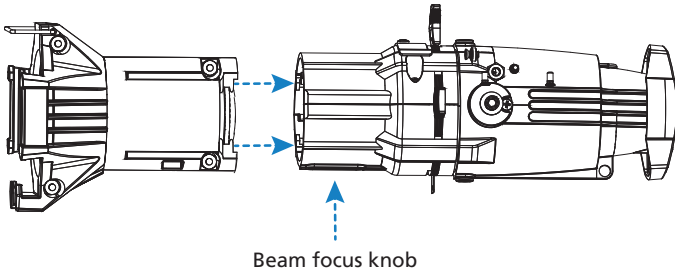

# Install OneTrack Luminaire



**WARNING:** To reduce the risk of fire and electric shock, use the track-mount luminaire only with its designated track system (for example, One Track or DataTrack).

**AVERTISSEMENT :** Pour éviter le risque d'incendie ou de choc électrique, utiliser le luminaire à adaptateur pour rail uniquement avec son système de rail désigné (OneTrack ou DataTrack par exemple).

1. Before you begin, verify that the adapter is unlocked. (Images at right show just the OneTrack adapter.)

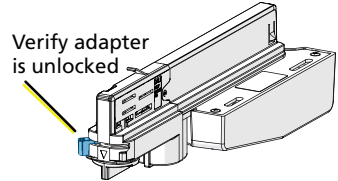

2. Orient the adapter so that the two tabs are aligned with the groove in the track, and then insert the adapter into the track. The tab at the end of the adapter locks into the track when the fixture is fully seated.

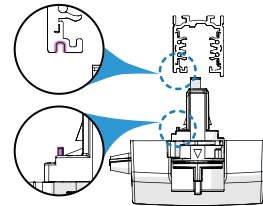

Align tabs to groove

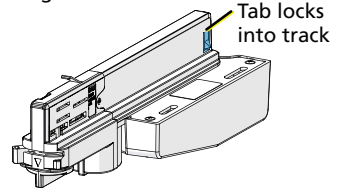

3. Flip the locking tab to the opposite side to lock the adapter, and then rotate the circuit selection knob to select the correct circuit.
4. Focus the luminaire.

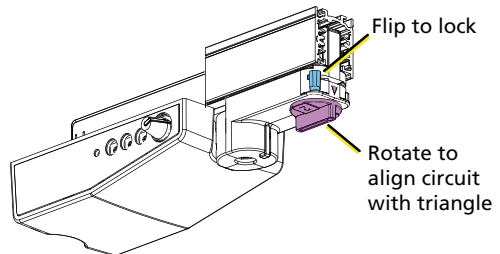

# Install DataTrack Luminaire



**WARNING:** To reduce the risk of fire and electric shock, use the track-mount luminaire only with its designated track system (for example, One Track or DataTrack).

**AVERTISSEMENT :** Pour éviter le risque d'incendie ou de choc électrique, utiliser le luminaire à adaptateur pour rail uniquement avec son système de rail désigné (OneTrack ou DataTrack par exemple).



**WARNING:** Use the DataTrack track-mount luminaire with ceiling-mounted track only.

1. Insert the DataTrack adapter into the track. The adapter only fits into the track one way with the tabs nesting into the track's groove.
2. Rotate the locking mechanism to lock the adapter into place.

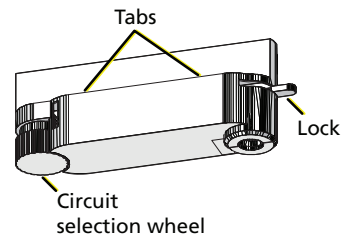

3. Use the circuit selection lock to select the circuit. The desired circuit number should point toward the center of the adapter.
4. Focus the luminaire.
5. Lock the luminaire into place using the yoke lock.

Cable protection posts on both the yoke lock and the yoke prevent the luminaire from rotating a full 360°. To lock the yoke in place use a 1.5 mm hex key.

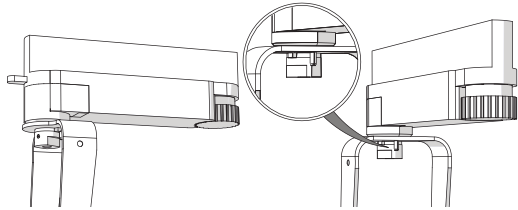

# Use with HALO Miniature Trac or GLOBAL Trac Pro

ETC offers the option of custom-ordering the Source Four Mini LED luminaire with track adapters that are compatible with the following track systems (even though these track systems are not available from ETC):

- HALO® Miniature Trac systems (not compatible with HALO TEK or HALO Lazer-Trac systems)
- GLOBAL Trac® Pro systems

To use the GA69 adapter with the Source Four Mini LED luminaire in a GLOBAL Trac Pro installation, consult the user documentation provided with that system.

To use the AD1 adapter with the Source Four Mini LED luminaire in a HALO Miniature Trac installation, push the tab on the adapter to the lower position (see image at right).



To install a luminaire with the AD1 adapter:

1. Pull back on the retaining sleeve.
2. Insert the adapter into the track with the gold tabs parallel to the track.
3. Release the sleeve and rotate until you feel the adapter snap securely into place.

# Install Canopy Luminaire



**WARNING: RISK OF ELECTRIC SHOCK! Power must be off when you perform this procedure.**

The luminaire must be installed by a qualified electrician in accordance with all national and local electrical and construction codes and regulations.

**AVERTISSEMENT : RISQUE DE DÉCHARGE ÉLECTRIQUE!**  
L'alimentation doit être éteinte avant d'exécuter cette procédure.

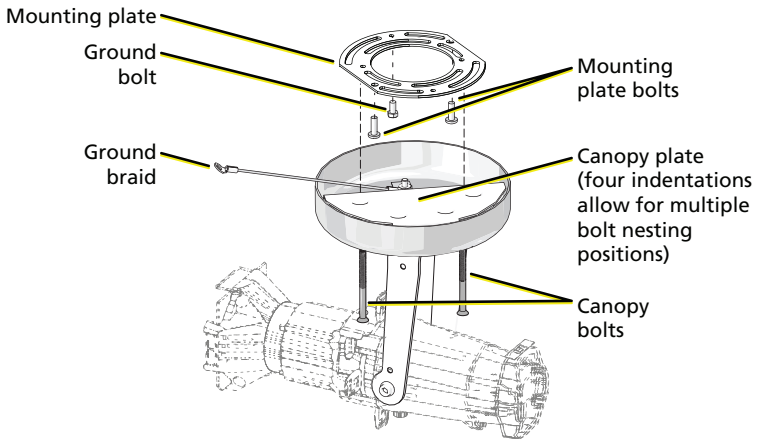

1. Remove the mounting plate from the luminaire by removing the two canopy bolts and the ground bolt. Set the ground bolt aside.
2. Using the mounting plate bolts, secure the mounting plate to the installed back box (not included).



**CAUTION:** *The canopy plate has built-in indentations allowing the mounting plate bolts to nest into the canopy plate. For an ideal flush-mount installation, you may need to rotate the plate to accommodate these indentations. See the following image.*

Mounting plate  
installation detail

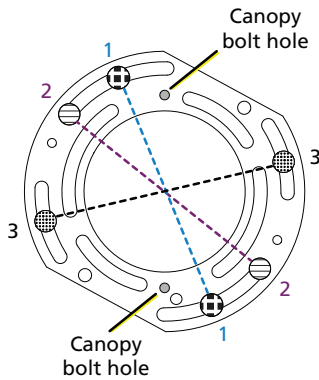

Install the mounting plate screws in one of the three position-pairings shown. Only the slots on the outer circumference will allow a true flush mounting.

3. Place the copper ground braid loop over the ground bolt and attach the ground bolt to the back box.
4. Connect the building ground wire to the ground wire on the luminaire, following local electrical codes.
5. Connect the supply power wires to the luminaire wiring using the included WAGO® connectors.
  - For 120 V luminaires: Connect the black wire to line and the white wire to neutral.
  - For 230 V luminaires: Connect the brown wire to line and the blue wire to neutral.
6. Use the canopy bolts to secure the luminaire to the mounting plate.
7. Open all four shutter blades by sliding them outward until they stop.
8. Install a gobo and gel as desired and confirm that they are properly secured.
9. Restore power at the disconnect device.
10. Focus the luminaire as needed.

# Focus and Setup

## Adjust the Tilt

1. Loosen, but do not remove the yoke locking knob.
2. Tilt the luminaire as needed.
3. Tighten the yoke locking knob.

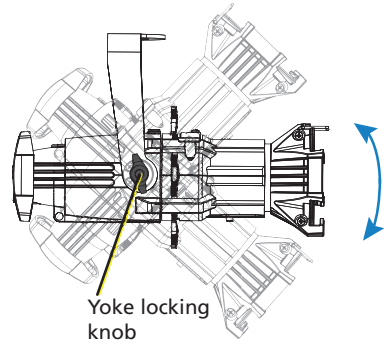

## Focus the Beam

Loosen the beam focus knob, adjust the lens tube position as needed, and then tighten the knob.

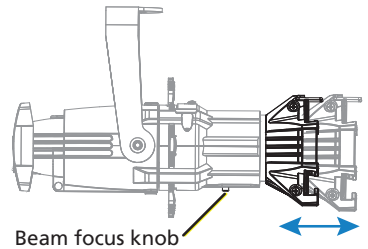

## Shape the Beam

You can shape the beam using the four shutters or with a pattern.

### Shape the Beam with Shutters

The luminaire has four shutters: left, right, top, and bottom. Each shutter can be pulled out or pushed in to create the desired beam shape.

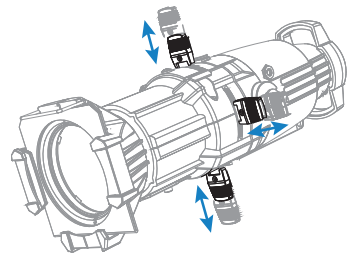

## Shape the Beam with a Pattern

The luminaire has a pattern-holder slot on the top side of the shutter barrel, in front of the shutter. It accommodates a glass or stainless steel E-size (37.5 mm with a 25.4 mm image area) pattern. The maximum pattern thickness that can be accommodated is 1.1 mm (0.04 in).

Use an optional donut in the color frame holder to enhance pattern projection.

When the slot is not in use, a small sheet metal cover secured with a Phillips screw prevents light leakage.

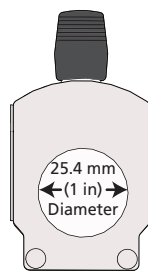

1. Use a Phillips screwdriver to loosen the screw on the slot cover. Do not remove the screw.
2. Slide the cover knob on the luminaire completely to the side to expose the slot.
3. Insert the pattern holder.
4. Slide the slot cover back toward the shutters until it meets the pattern handle. Leave enough space to move the handle.
5. Secure the slot cover by tightening the screw.

## Use the Color Frame Holder

The Source Four Mini LED comes equipped with a color frame (either 70 mm or 2 3/4 in), which is a metal frame used to hold color media (often referred to as gel) in front of the lens. The color frame holder is equipped with a retaining clip that prevents the color frame from falling out.

Additional accessories are available that also fit into the color frame holder: top hat, short top hat, half hat, short half hat, and donut. When you use an accessory, install the color frame in the rear slot of the holder.



**WARNING:** Check that the accessory holder is locked before mounting the luminaire.

**AVERTISSEMENT :** Vérifiez que le porte-accessoires est verrouillé avant de monter le projecteur.



**Note:** The color frame should be inserted with the open side down.

1. Release the retaining clip by gently pushing it up.
2. Insert the color frame.
3. Lock the retaining clip by gently pushing it down.

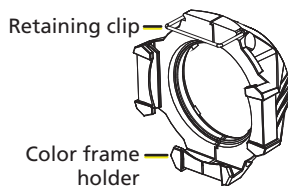



# Cleaning

---



**WARNING: Do not use ammonia-based cleaners or other harsh commercial cleaners. Clean lens only as directed.**

**Commercially available glass cleaning agents should be avoided as they may contain ammonia, other harsh chemical detergents, or abrasive agents. These cleaners may damage the lens surface. Do not immerse or soak the lens in any cleaning solution.**

---

1. Remove the beam focus knob from the shutter barrel.
2. Remove the lens tube from the shutter barrel.
3. Remove dust with a blast of oil-free air or wipe with a clean, lint-free cloth.
4. Slide the lens tube back into the shutter barrel with the color frame retainer clip on the top.
5. Reinstall the beam focus knob.

# Specifications and Reference

For current and complete compliance and specifications, see the Source Four Mini LED datasheet at [etconnect.com](http://etconnect.com).

## FCC Compliance

### Source Four Mini LED

(For any FCC matters):

Electronic Theatre Controls, Inc.  
3031 Pleasant View Road  
Middleton, WI 53562  
+1 (608) 831-4116  
[etconnect.com](http://etconnect.com)

This device complies with Part 15 of the FCC Rules. Operation is subject to the following two conditions: (1) this device may not cause harmful interference, and (2) this device must accept any interference received; including interference that may cause undesired operation. Visit [etconnect.com/products](http://etconnect.com/products) for current and complete compliance information including FCC compliance.



**Note:** *This equipment has been tested and found to comply with the limits for a Class A digital device, pursuant to Part 15 of the FCC rules. These limits are designed to provide reasonable protection against harmful interference when the equipment is operated in a commercial environment. This equipment generates, uses, and can radiate radio frequency energy and, if not installed and used in accordance with the instructions, may cause harmful interference to radio communications. Any modifications or changes to this product not expressly approved by Electronic Theatre Controls, Inc. could void the user's authority to operate the product. Operation of this equipment in a residential area is likely to cause harmful interference, in which case the user will be required to correct the interference at their own expense.*

---





**Corporate Headquarters** ■ Middleton, WI, USA | +1 608 831 4116  
**Global Offices** ■ London | Rome | Holzkirchen | Paris | Hong Kong | Dubai | Singapore  
New York | Orlando | Los Angeles | Austin | © 2024 Electronic Theatre Controls, Inc.  
**Web** [etcconnect.com](https://etcconnect.com) | **Support** [support.etcconnect.com](https://support.etcconnect.com)  
**Contact** [etcconnect.com/contactETC](https://etcconnect.com/contactETC) | Trademark and patent info: [etcconnect.com/ip](https://etcconnect.com/ip)  
Third-party license agreement info: [etcconnect.com/licenses](https://etcconnect.com/licenses) | Product information and specifications subject to change. ETC intends this document to be provided in its entirety.  
7063M1220 Rev K Released 2024-09